



DQ SURGICAL

# MAJOR SURGICAL SET

<i>SCALPEL HANDLES</i>	PAGE 1
<i>SCISSORS</i>	PAGE 2
<i>NEEDLE HOLDERS</i>	PAGE 3
<i>RETRACTORS</i>	PAGE 4
<i>TOWEL CLAMPS</i>	PAGE 5
<i>DRESSING FORCEPS</i>	PAGE 6
<i>FORCEPS</i>	PAGE 7 - 8

DQ SURGICAL GmbH  
Bünigerstr. 1  
79224 Umkirch  
Germany

Fon +49 (0) 7665 8087605  
Fax +49 (0) 7665 8087604  
info@dqsurgical.de  
www.dqsurgical.de

# SCALPEL HANDLES



1/1

Standard  
01-001-03  
No. 3  
5 pcs



1/1

01-002-04  
No. 4  
5 pcs



# SCISSORS

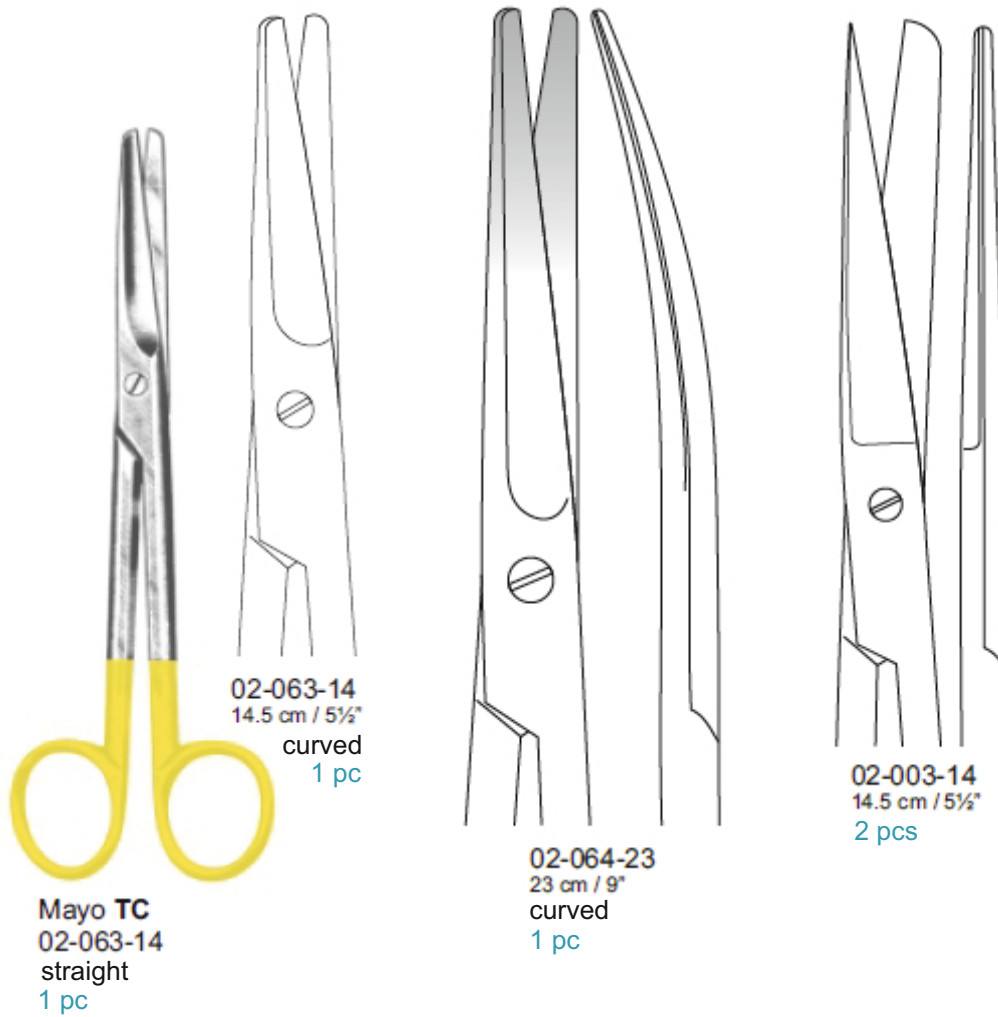

# NEEDLE HOLDERS

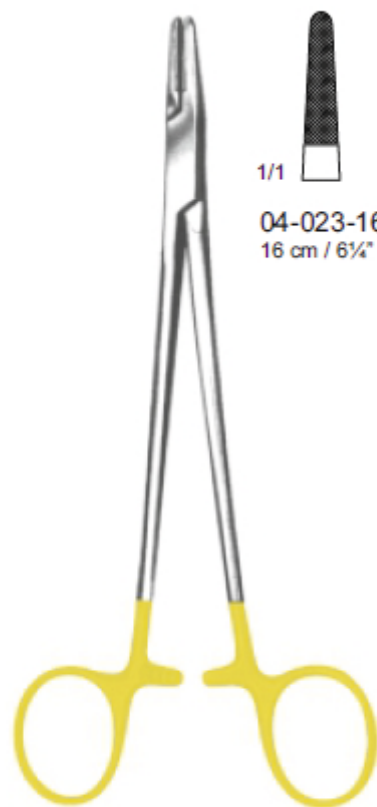

1/1

04-023-16  
16 cm / 6¼"

Mayo-Hegar TC  
04-023-16  
2 pcs



# RETRACTORS



Us-Army Retractor  
09-036-00  
21 cm / 8¼"  
2 \* 2 pcs

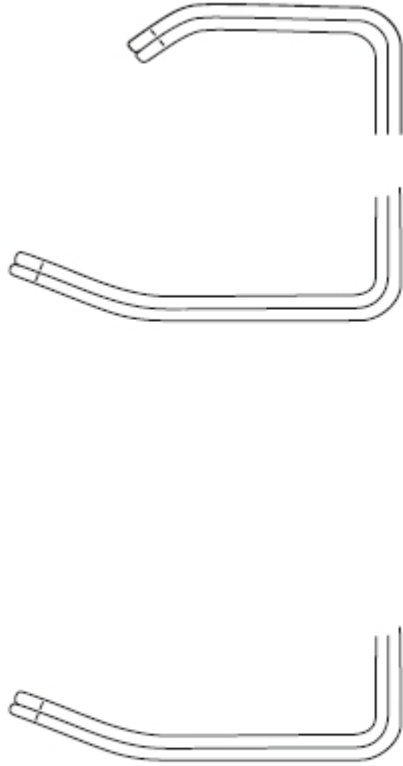

Senn-muller  
09-005-01 - 09-005-02  
16.5 cm / 6½"

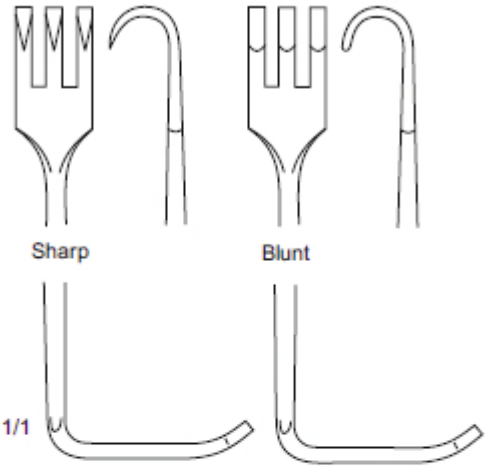

Sharp

Blunt

1/1

09-005-01  
2 pcs

09-005-02  
2 pcs



# TOWEL CLAMPS



Backhaus

03-048-11 11 cm / 4½"  
12 pcs



# DRESSING FORCEPS



05-001-16  
16 cm / 6¼"  
2 pcs

Standard / Dressing



05-002-16  
16 cm / 6¼"  
2 pcs

Tissue 1x2 Teeth

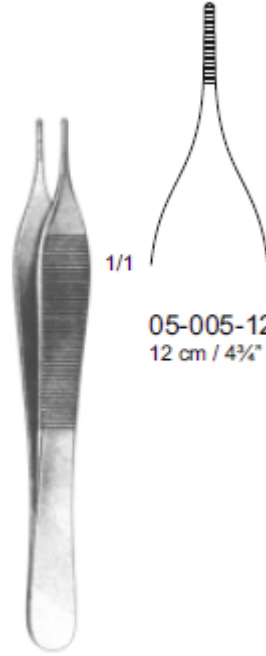

1/1

05-005-12  
12 cm / 4¾"

Adson  
05-005-12  
2 pcs



05-006-12  
12 cm / 4¾"  
1x2 Teeth  
2 pcs



1/1

Adson-Brown  
05-007-12  
12 cm / 4¾"  
2 pcs



# FORCEPS

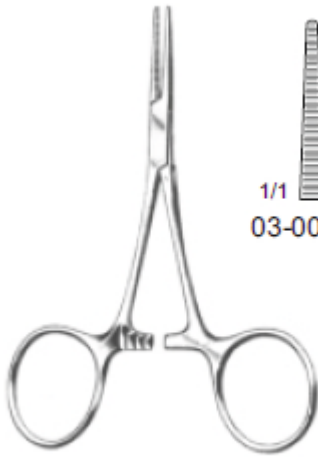

1/1  
03-001-10

**Hartmann**  
03-001-10  
10 cm / 4"  
3 pcs



1/1  
03-016-14  
12 pcs

**Crile**  
14 cm / 5½"



03-017-14  
12 pcs



**Péan (Rochester)**

03-032-20  
20 cm / 8"  
3 pcs

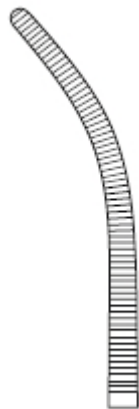

03-033-20  
20 cm / 8"  
3 pcs



**Halsted-Mosquito**

1/1  
03-003-12  
12,5 cm / 5"  
6 pcs



03-004-12  
12,5 cm / 5"  
6 pcs

03-032-16  
16 cm / 6¼"  
3 pcs



03-033-16  
16 cm / 6¼"  
3 pcs





# FORCEPS

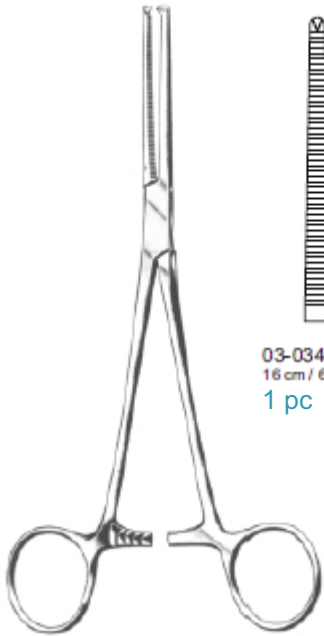

03-034-16  
16 cm / 6 1/2"  
1 pc

03-035-16  
16 cm / 6 1/2"  
1 pc

Kocher (Ochsner)



03-087-18  
18 cm / 7"  
2 pcs

Babcock

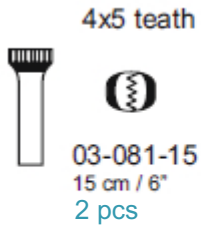

4x5 teeth  
03-081-15  
15 cm / 6"  
2 pcs



Allis  
03-081-15

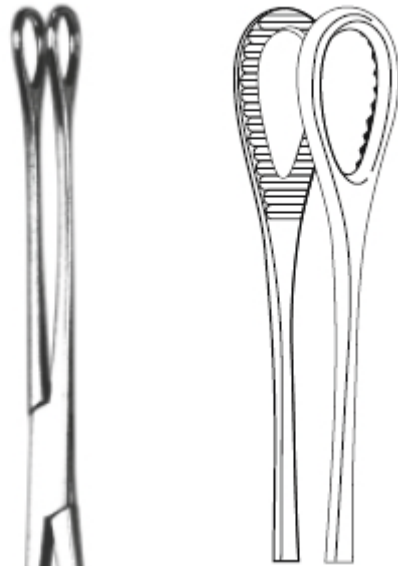

03-053-25 25 cm / 10"  
Str.  
2 pcs

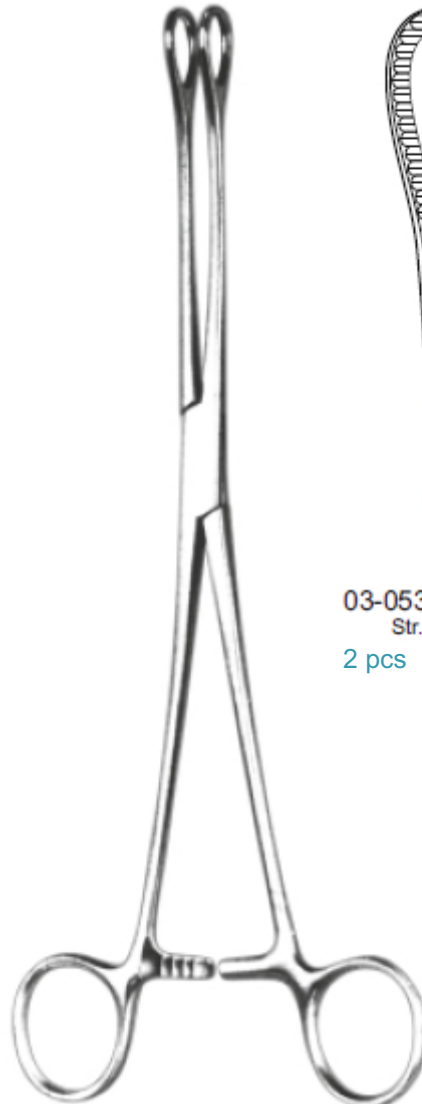

Foerster

