

	
<p>Catheter Introducing Forceps AH-01-2701 14.5 CM 25 CM</p>	<p>Laryngoscope Sets AH-01-2702</p>
	
<p>Laryngoscope Sets AH-01-2703</p>	<p>Laryngoscope Blade Fig.0 Fig.1 Fig.2 Fig.3 Fig.4 AH-01-2704</p>

	
<p>Laryngoscope Blades Fig.1 Fig.2 Fig.3 Fig.4 AH-01-2707</p>	<p>Laryngoscope Sets AH-01-2708</p>
	
<p>Laryngoscope Sets Fig.1 Fig.2 Fig.3 Fig.4 AH-01-2709</p>	<p>Laryngoscope Blades Fig.0 Fig.1 Fig.2 Fig.3 AH-01-2710</p>

	
<p>McIntosh AH-01-2711</p>	<p>Battery Handle AH-01-2712</p>
	
<p>Laryngoscope Blades Fig.1 Fig.2 Fig.3 AH-01-2713</p>	<p>Laryngoscope Sets fiber optic Fig.1 Fig.2 Fig.3 AH-01-2714</p>

	
<p>Laryngoscope Sets fiber optic Fig.1 Fig.2 Fig.3 AH-01-2715</p>	<p>Laryngoscope Blade Fig.0 Fig.1 Fig.2 Fig.3 AH-01-2716</p>
	
<p>Bone Shear 23 cm AH-01-1301</p>	<p>Rib Shear 23 cm AH-01-1302</p>



Rib Shears  
23cm  
AH-01-1303



Sternum Chisel  
24.5 cm  
AH-01-1304







Rib Retractor lateral blades 18 x 21 mm  
spreading 75 mm  
1  
AH-01-1305



Rib Retractor lateral blades 36 x 45 mm  
spreading 170 mm  
1  
AH-01-1306





	
<p>Rib Retractor lateral blades 45 x 65 mm spreading 200 mm 1 AH-01-1307</p>	<p>Rib Retractor lateral blades 65 x 65 mm spreading 220 mm 1 AH-01-1308</p>
	
<p>Rib Retractor with two pairs of blades 30 x 80 mm + 40 x 67 mm, spreading 220 mm 1 AH-01-1309</p>	<p>Rib Retractor lateral blades 14 x 15 mm spreading 120 mm 1 AH-01-1310</p>

	
<p>Sternal Retractor 4 movable blades 17 x 22 mm spreading 160 mm Sternal Retractor 1 AH-01-1311</p>	<p>Sternal Retractor 4 movable blades 22 x 27 mm spreading 200 mm 1 AH-01-1312</p>
	
<p>Rib Retractor lateral blades 14 x 15 mm spreading 75 mm 1 AH-01-1313</p>	<p>Rib Retractor lateral blades 30 x 45 mm spreading 150 mm 1 AH-01-1314</p>





	
<p>Bone Shear 23 cm AH-01-1315</p>	<p>Rib Retractor spreading 200 mm with 3 pairs of blades 1 AH-01-1316</p>
	
<p>Thoracic Retractor 1 AH-01-1317</p>	<p>Rib Contractor 20 cm AH-01-1318</p>









	
<p>Rib Contractor 15.5 cm AH-01-1319</p>	<p>Rib Contractor 20 cm AH-01-1320</p>
	
<p>Milium Knife 14 cm AH-01-2001</p>	<p>Lupus Scraper 13 cm AH-01-2002</p>

	
<p>Lupus Curette 14 cm AH-01-2003</p>	<p>Skin Hooklet 14.5 cm AH-01-2004</p>
	
<p>Face-lift Hook 13 cm AH-01-2005</p>	<p>Face-lift Hook 13 cm AH-01-2006</p>

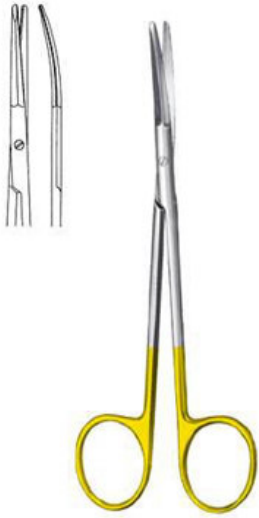
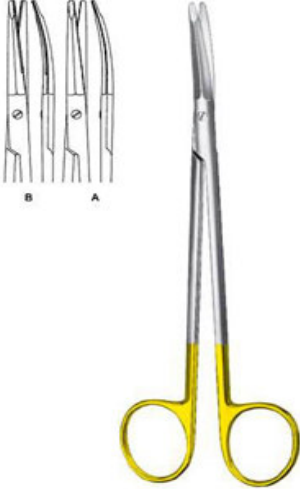

	
<p>Dermal Punch 5.5 cm AH-01-2007</p>	<p>Handle 8 cm AH-01-2008 C</p>
	
<p>Dermal Punch 11 cm AH-01-2009</p>	<p>Rib Retractor lateral blades 10,5 x 32 mm spreading 65 mm 1 AH-01-2010</p>

	
<p>Comedone Extractor          14.5 cm          AH-01-2011</p>	<p>Comedone Extractor          11 cm          AH-01-2012</p>
	
<p>Saalfeld Comedone Extractor          14.5 cm          AH-01-2013</p>	<p>Comedone Extractor          16 cm          AH-01-2014</p>





	
<p>Comedone Extractor 11.5 cm AH-01-2015</p>	<p>Face-lift Forceps 18 cm AH-01-2016</p>
	
<p>Face-lift Scissors 14 cm AH-01-2017</p>	<p>Face-lift Scissors 15 cm 18 cm AH-01-2018</p>

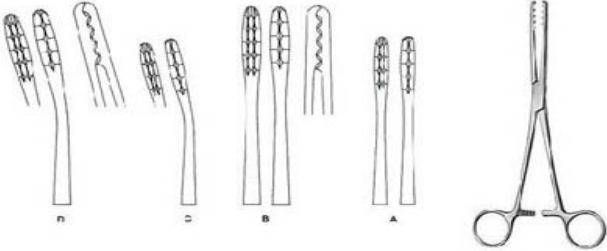

	
<p>Face-lift Scissors 18 cm AH-01-2019</p>	<p>Face-lift Scissors 18 cm AH-01-2020</p>
	
<p>Percussion Hammer 18.5 cm AH-01-2601</p>	<p>Buck 20 cm AH-01-2602</p>



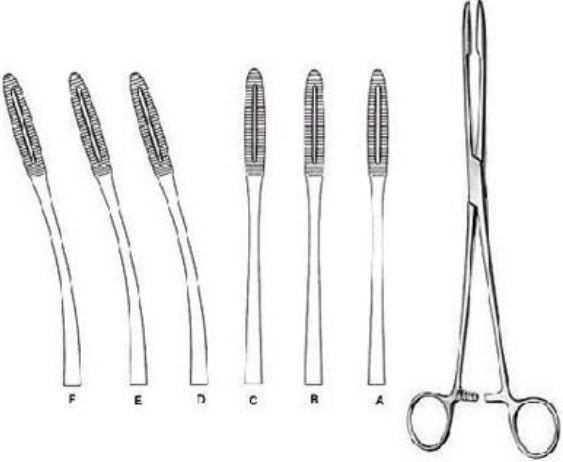

	
<p>Spare Blade          16cm          AH-01-2603</p>	<p>Percussion Hammer          20 cm          AH-01-2604</p>
	
<p>Percussion Hammer          21 cm          AH-01-2605</p>	<p>Percussion Hammer          20 cm          AH-01-2606</p>



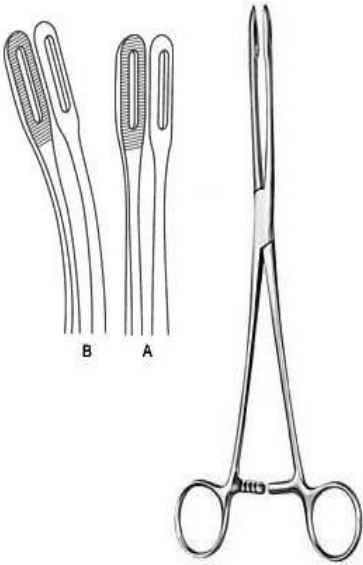

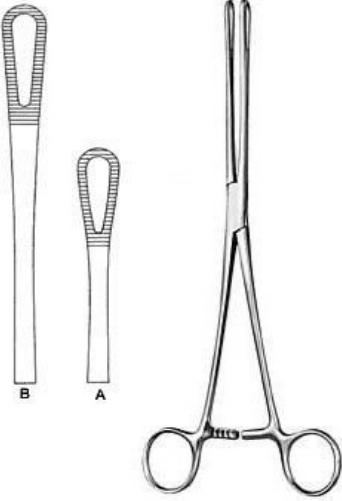
	
<p>Pinwheel 18 cm AH-01-2607</p>	<p>Stethoscope 18 cm AH-01-2608</p>
	
<p>Stethoscope 15 cm AH-01-2609</p>	<p>DRESSING &amp; SPONGE FORCEPS 12cm AH-01-2801</p>









	
<p>DRESSING &amp; SPONGE FORCEPS 12cm AH-01-2802</p>	<p>DRESSING &amp; SPONGE FORCEPS 12cm AH-01-2803</p>
	
<p>DRESSING &amp; SPONGE FORCEPS 12cm AH-01-2804</p>	<p>DRESSING &amp; SPONGE FORCEPS 18cm AH-01-2805</p>



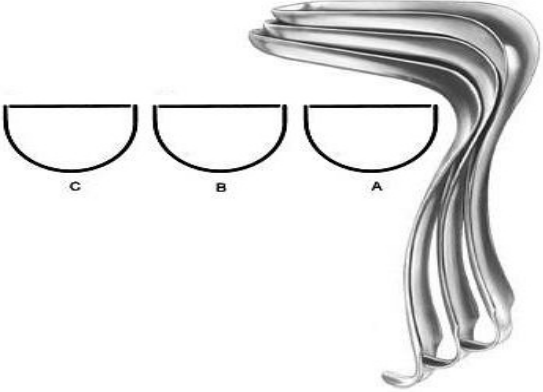

	
<p>DRESSING &amp; SPONGE FORCEPS 12cm AH-01-2806</p>	<p>DRESSING &amp; SPONGE FORCEPS 12cm AH-01-2807</p>
	
<p>DRESSING &amp; SPONGE FORCEPS 18cm AH-01-2808</p>	<p>DRESSING &amp; SPONGE FORCEPS 18cm AH-01-2809</p>

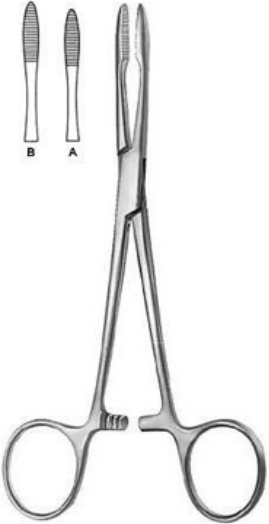

	
<p>DRESSING &amp; SPONGE FORCEPS          12cm          AH-01-2810</p>	<p>Dressing &amp; Tissue Forceps          12.5 cm          AH-501</p>
	
<p>Dressing &amp; Tissue Forceps          18 CM          AH-502</p>	<p>Dressing &amp; Tissue Forceps          13 cm          AH-503</p>

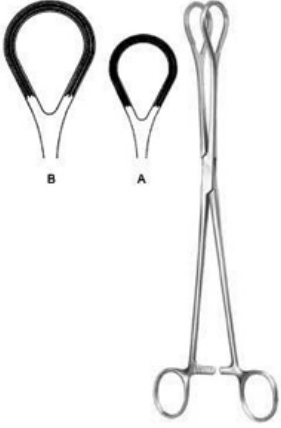
	
<p>Dressing &amp; Tissue Forceps          18.5 cm          AH-511</p>	<p>Dressing &amp; Tissue Forceps          15.5 cm          AH-512</p>
	
<p>Dressing &amp; Tissue Forceps          12 cm          AH-516</p>	<p>Dressing &amp; Tissue Forceps          17.5 cm          AH-517</p>

	
<p>Vaginal Speculum 75 X 18 MM AH-01-2302</p>	<p>Vaginal Speculum 100 X 35 MM 85 X 30 MM AH-01-2305</p>
	
<p>Vaginal Retractor 110 x 14 mm AH-01-2312</p>	<p>Vaginal Retractor 115 x 23 mm AH-01-2317</p>

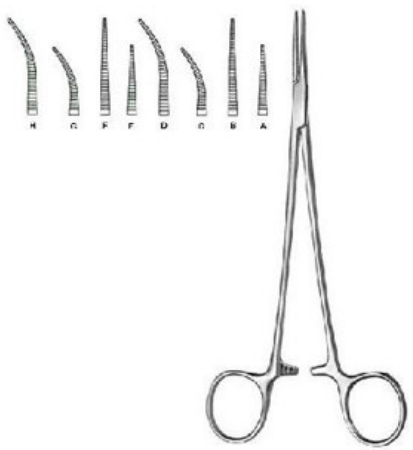
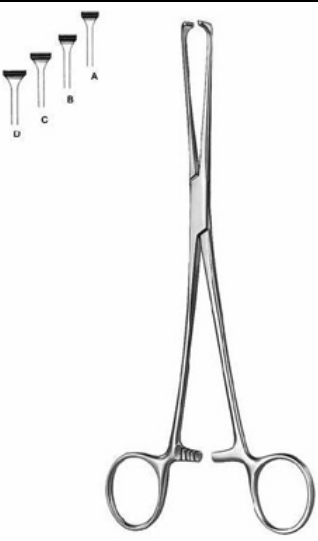

	
<p>Vaginal Retractor 70 x 40 mm Fig.1 90 x 40 mm Fig.2 AH-01-2319</p>	<p>Vaginal Speculum 70 x 33 mm 90 x 33 mm AH-01-2320</p>
	
<p>Haemostatic Forceps 16 cm AH-701</p>	<p>Haemostatic Forceps 12.5 cm AH-704</p>



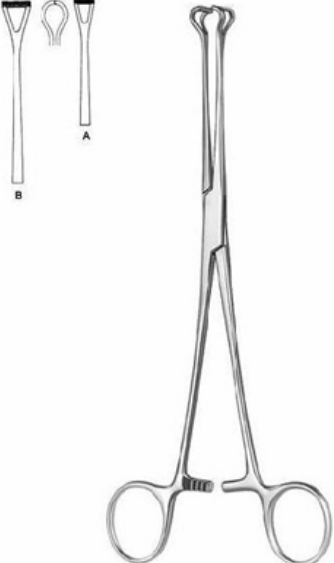
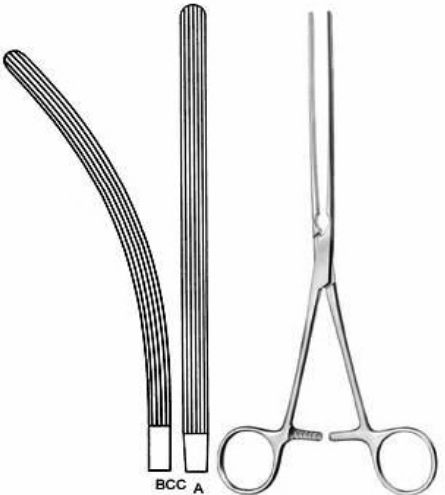
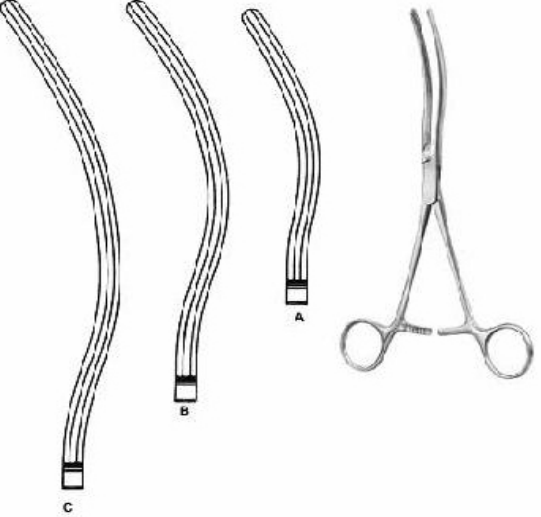

	
<p>Haemostatic Forceps 12cm AH-706</p>	<p>Haemostatic Forceps 15.5 cm AH-707</p>
	
<p>Haemostatic Forceps 17 cm AH-708</p>	<p>Haemostatic Forceps 15 cm AH-710</p>





	
<p>Haemostatic Forceps 13 cm AH-713</p>	<p>Haemostatic Forceps 14 cm AH-716</p>
	
<p>Intestinal and Tissue Grasping Forceps 30 cm AH-01-2103</p>	<p>Intestinal and Tissue Grasping Forceps 20 cm AH-01-2108</p>











	
<p>Intestinal and Tissue Grasping Forceps          16.5 cm          AH-01-2109</p>	<p>Intestinal and Tissue Grasping Forceps          16 cm          AH-01-2112</p>
	
<p>Intestinal Clamp          24.5 cm          25.5 cm          AH-01-2117</p>	<p>Intestinal Clamp          27.5 cm          AH-01-2119</p>



	
<p>Wire Saw Handle AH-01-1201</p>	<p>Wire Saw Guide 33 cm AH-01-1202</p>
	
<p>Skull Traction Tong small pattern AH-01-1203</p>	<p>Skull Traction Tong large pattern 22.5 cm AH-01-1204</p>



	
<p>Cranial Rongeur AH-01-1205 2mm,3.5mm</p>	<p>Clip Applying Forceps 15cm \$18.00</p>
	
<p>Clip Applying Forceps 18.5 cm AH-01-1207</p>	<p>Dura Dissector 18 cm AH-01-1208</p>

	
<p>Dura Dissector sharp 21.5 cm AH-01-1211</p>	<p>Nerve Root Retractor 20 cm AH-01-1214</p>
	
<p>Brain Spatula 18 cm AH-01-1215</p>	<p>Nerve Root Retractor 8mm 23.5 cm AH-01-1216</p>



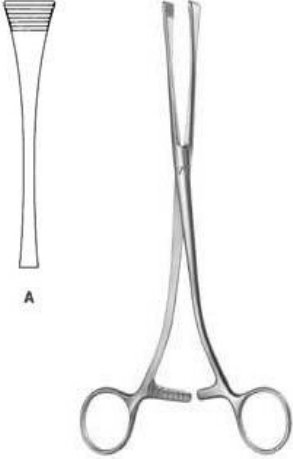
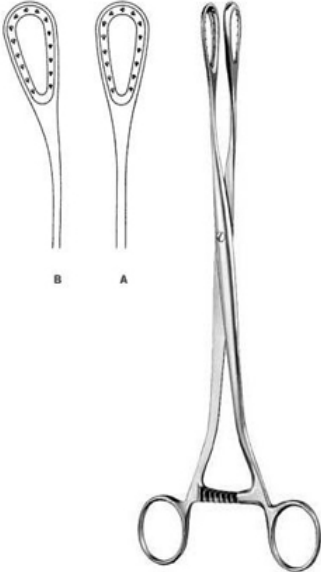

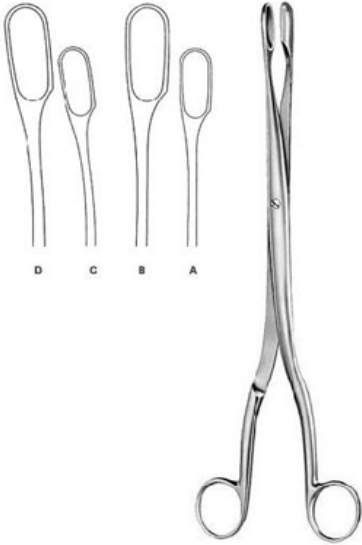
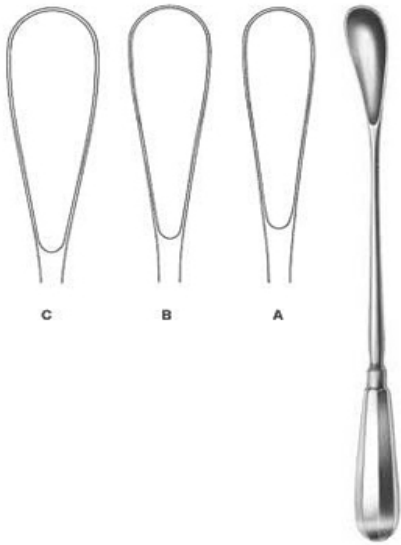
	
<p>Nerve Root Retractor 8mm          23.5 cm          AH-01-1217</p>	<p>Nerve Root Retractor 7mm          16.5 cm          AH-01-1218</p>
	
<p>Nerve Hook          26.5 cm          AH-01-1219</p>	<p>Nerve Hook          26.5 cm          AH-01-1220</p>

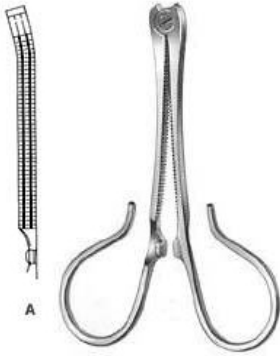



	
<p>Pelvimeter cm, inch scale        34 CN        AH-01-2401</p>	<p>Obstetrical Forceps        35 cm        40.5 cm        AH-01-2402</p>
	
<p>Obstetrical Forceps        33 cm        AH-01-2403</p>	<p>Obstetrical Forceps        28 cm        AH-01-2404</p>





	
<p>Obstetrical Forceps 36.5 cm AH-01-2405</p>	<p>Obstetrical Forceps 42 cm AH-01-2406</p>
	
<p>Uterine Clamp 21 cm AH-01-2407</p>	<p>Placenta and Ovum Forceps 27 cm AH-01-2408</p>





	
<p>Placenta and Ovum Forceps 28 cm Fig.1 28 cm Fig.2 AH-01-2409</p>	<p>Placenta Scoop 30 cm 14.5 mm 30 cm 18 mm AH-01-2410</p>
	
<p>Placenta Scoop 30 cm AH-01-2411</p>	<p>Umbilical Cord Clamp 8.5 cm AH-01-2412</p>









	
<p>Umbilical Cord Clamp 8.5 cm AH-01-2413</p>	<p>Barraquer 1 AH-01-1401</p>
	
<p>Bowman 1 AH-01-1402</p>	<p>Critchett 1 AH-01-1403</p>



	
<p>Smith 1 AH-01-1404</p>	<p>Clark 1 AH-01-1405</p>
	
<p>Graefe 1 AH-01-1406</p>	<p>Week 1 AH-01-1407</p>



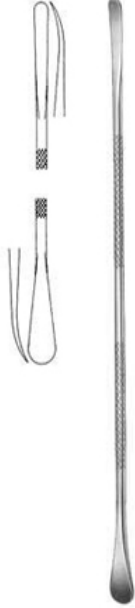

	
<p>Arruga          1          AH-01-1408</p>	<p>Arruga          1          AH-01-1409</p>
	
<p>Mellinger Axenfeld          1          AH-01-1410</p>	<p>Mellinger Axenfeld          1          AH-01-1411</p>

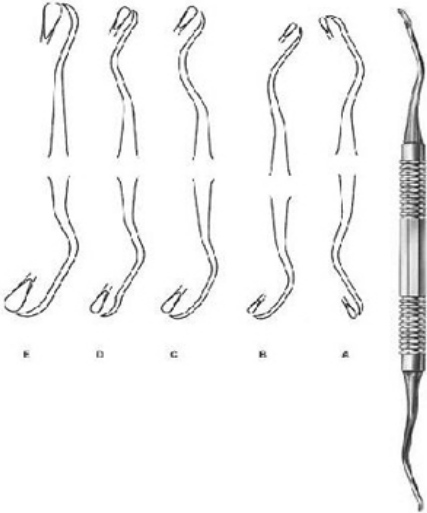
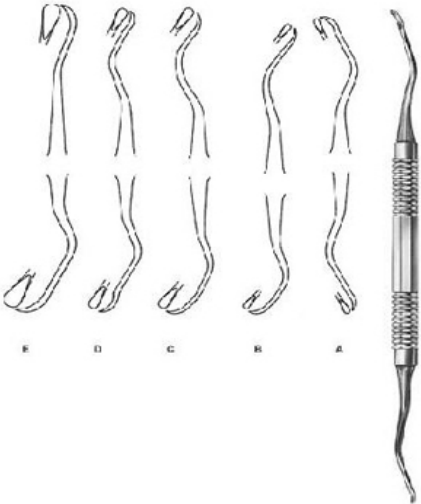
	
<p>Mellinger 1 AH-01-1412</p>	<p>Lister Burch 1 AH-01-1413</p>
	
<p>Williams 7 CM 8.3 CM AH-01-1414</p>	<p>Lancaster 1 AH-01-1415</p>

	
<p>AHegler 1 AH-01-1416</p>	<p>Mueller 1 AH-01-1417</p>
	
<p>Jaeger 20 mm 23 mm 4" AH-01-1418</p>	<p>Graefe 1 2 3 4 5 AH-01-1419</p>



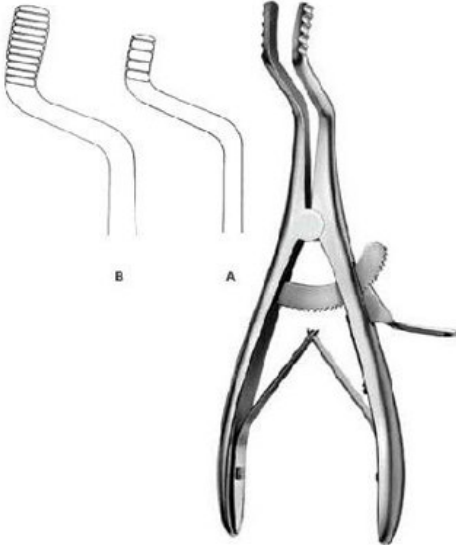

	
<p>Jaegar        1        AH-01-1420</p>	<p>Elevator        17 cm        AH-01-1701</p>
	
<p>Elevator        17.5 cm        AH-01-1702</p>	<p>Periosteal Elevator        18 cm        AH-01-1703</p>



	
<p>Periosteal Elevator 18 cm AH-01-1704</p>	<p>Sinus Lift Curette 15 cm 19 cm AH-01-1705</p>
	
<p>Sinus Lift Curette 18 cm AH-01-1706</p>	<p>Mouth Gag 13 cm AH-01-1707</p>





	
<p>Mouth Gag 18 cm AH-01-1708</p>	<p>Mouth Gag 13 cm AH-01-1710</p>
	
<p>Mouth Gag 16 cm AH-01-1712</p>	<p>Mouth Gag 13.5 cm AH-01-1714</p>

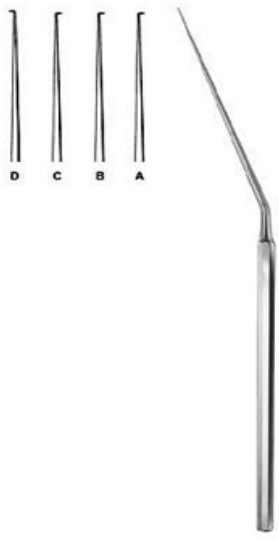









<p>Micro Ear Forceps shaft length 80mm, smooth straight, serrated straight 6CM AH-01-1501</p>	<p>Micro Ear Forceps shaft length 80mm, straight, bent upwards 6CM AH-01-1502</p>
<p>Micro Ear Scissors shaft length 80 mm 6CM AH-01-1503</p>	<p>Wire Bending Forceps Wire Bending Forceps shaft length 80 mm 6CM AH-01-1504</p>



	
<p>Malleus Nipper shaft length 80 mm 6CM AH-01-1505</p>	<p>Introducing Forceps shaft length 80 mm 6CM AH-01-1506</p>
	
<p>Rotary Knife 8CM AH-01-1507</p>	<p>Circular Cut Knife 15 cm Fig. 5 1.6 mm? AH-01-1508</p>

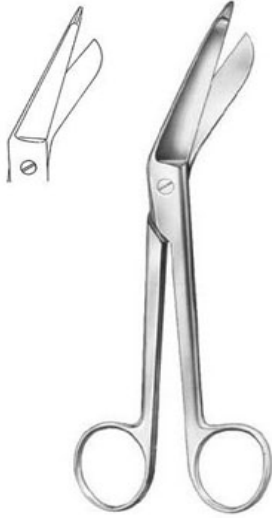

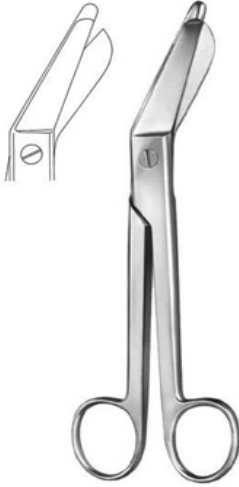
 <p>Four variants of a Micro Ear Needle, labeled D, C, B, and A, shown in a row. Below them is a full-length view of the needle.</p>	 <p>Four variants of a Micro Ear Hook, labeled D, C, B, and A, shown in a row. Below them is a full-length view of the hook.</p>
<p>Micro Ear Needle 0,3mm to 2,5mm 16 cm AH-01-1509</p>	<p>Micro Ear Hook 0,3mm to 1,0mm 15.5 cm AH-01-1510</p>
 <p>A Cheek Retractor with a curved, U-shaped head and a handle with a hole at the bottom.</p>	 <p>Four variants of a Micro Measuring Rod, labeled D, C, B, and A, shown in a row. Below them is a full-length view of the rod.</p>
<p>Cheek Retractor 10.5 cm AH-01-1511</p>	<p>Micro Measuring Rod 15.5 cm 4.5 mm AH-01-1512</p>

 <p>Diagram showing four pairs of micro curettes labeled A, B, C, and D, and a long, thin instrument with a textured handle.</p>	 <p>Diagram showing three ear specula labeled A, B, and C, and two smaller ones labeled D and E.</p>
<p>Micro Curette 8CM AH-01-1513</p>	<p>Ear Specula, Set 3.6 cm Fig. 0 3.6 cm Fig. 1 3.6 cm Fig. 2 AH-01-1514</p>
 <p>Diagram showing five ear specula labeled A, B, C, D, and E.</p>	 <p>Diagram showing five ear specula labeled A, B, C, D, and E, and a large, black, conical ear speculum.</p>
<p>Ear Specula, Set 3.8 cm AH-01-1515</p>	<p>Ear Speculum 3.6 cm AH-01-1516</p>

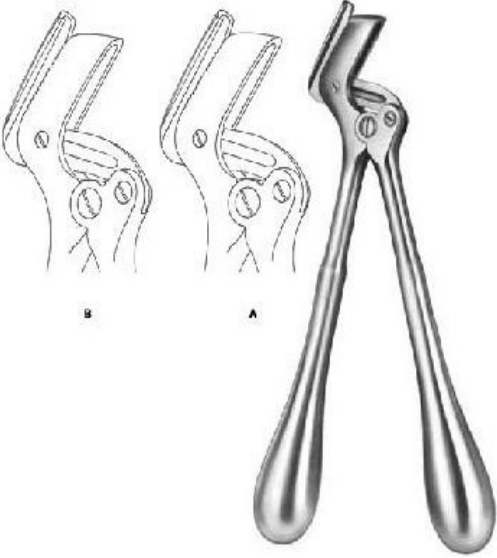
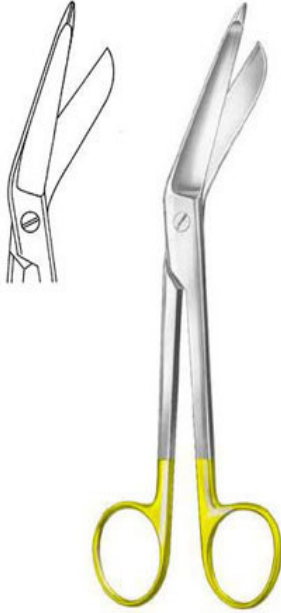

	
<p>Tuning Fork        c 2 512        AH-01-1517</p>	<p>Tuning Fork        c 128        AH-01-1518</p>
	
<p>Tuning Fork        c 128        AH-01-1519</p>	<p>Bandage Scissors heavy pattern        23 cm        AH-01-1101</p>

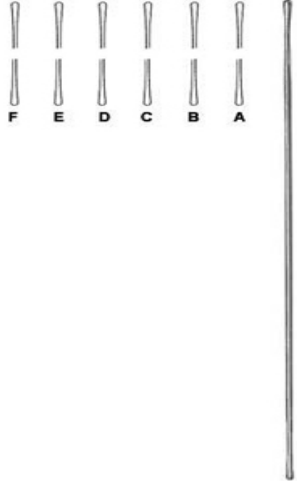

	
<p>Bandage Scissors 14.5 cm 18.5 cm 2/150 AH-01-1102</p>	<p>Plaster Shears 23.5 cm AH-01-1103</p>
	
<p>Plaster Shears heavy pattern, short blades 20 cm AH-01-1104</p>	<p>Bandage Scissors black plastic ring with autodavable 16 cm AH-01-1105</p>

	
<p>Bandage Scissors black plastic rings 19 cm AH-01-1106</p>	<p>Plaster Scissors 24 cm AH-01-1107</p>
	
<p>Plaster Shears 23 cm AH-01-1108</p>	<p>Bandage Scissors 18 cm AH-01-1109</p>

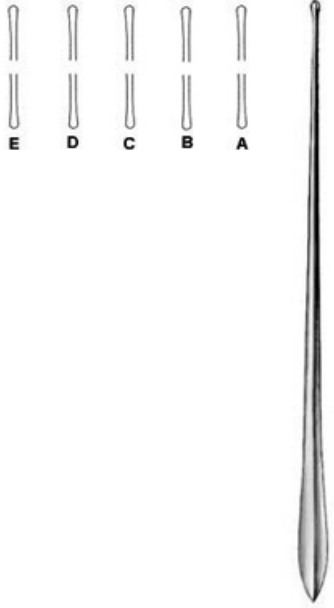
	
<p>Plaster Scissors 24 cm AH-01-1110</p>	<p>Probe 13 cm 14.5 cm AH-01-1001</p>
	
<p>Probe 30 cm AH-01-1002</p>	<p>Probe 16 cm AH-01-1003</p>



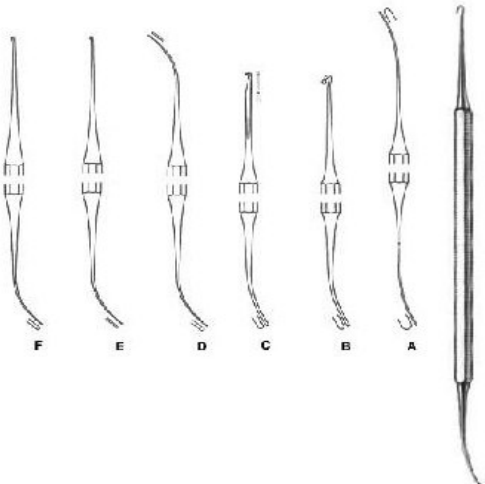

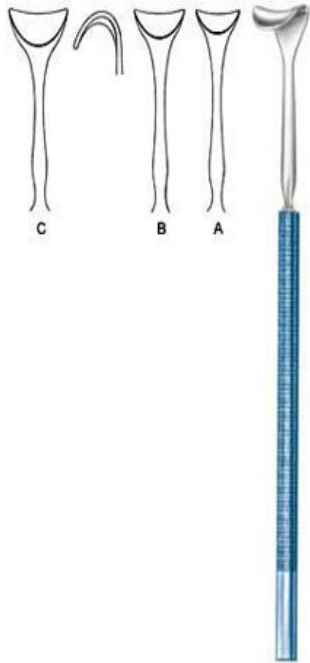

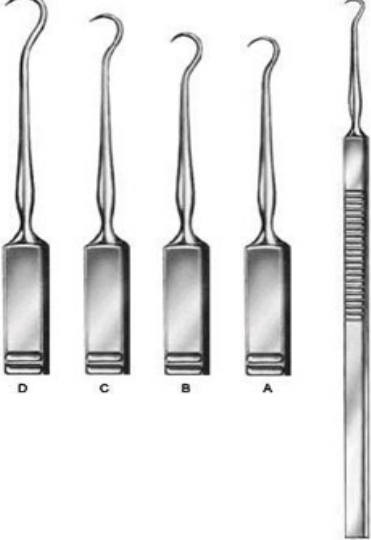
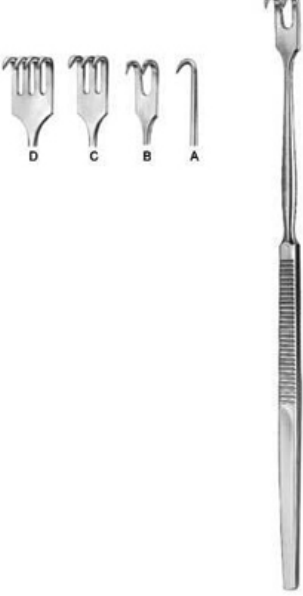
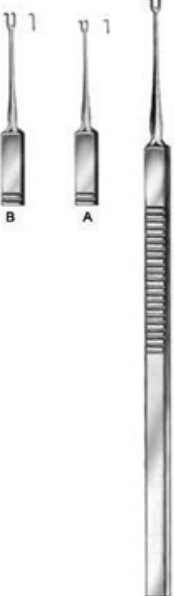

	
<p>Probe with eye 16 cm AH-01-1004</p>	<p>Myrtle Leaf Probe 13 cm AH-01-1005</p>
	
<p>Grooved Director 13 cm 14.0 cm AH-01-1006</p>	<p>Grooved Director 14.5 cm AH-01-1008</p>



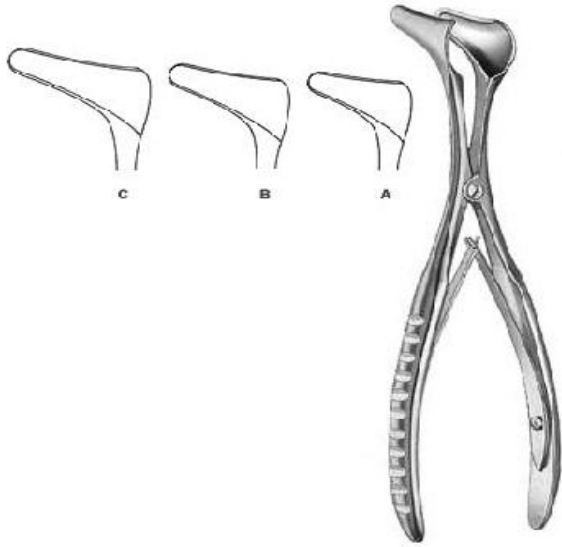

	
<p>Phlebotomizer 18 cm AH-01-1010</p>	<p>Bone Hooklet 17 cm AH-01-901</p>
	
<p>Hooklet 16 cm AH-01-903</p>	<p>Saddle Hook 14 cm AH-01-904</p>



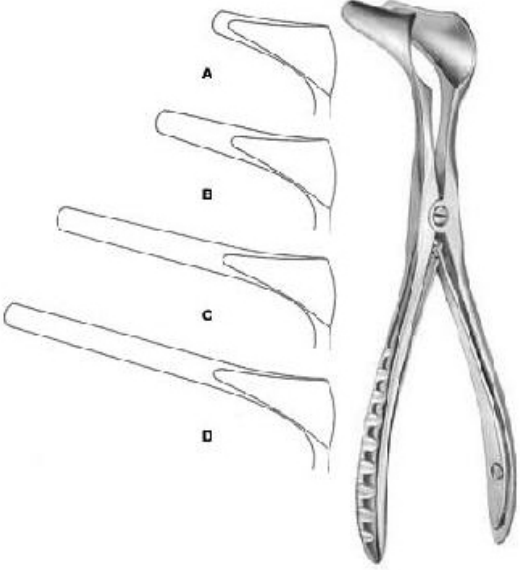

	
<p>Micro Hooklet 15 cm AH-01-905</p>	<p>Skin Hook 16 cm Fig.1 AH-01-906</p>
	
<p>Hooklet 16.5 cm AH-01-909</p>	<p>Skin Hook 15.5 cm AH-01-907</p>

<p>The image shows a long, thin surgical instrument with a textured handle and a hook-like head. To the left of the main instrument are four smaller versions of the head, labeled D, C, B, and A from left to right, showing different hook shapes.</p>	<p>The image shows a long, thin surgical instrument with a textured handle and a hook-like head. To the left of the main instrument are four smaller versions of the head, labeled D, C, B, and A from left to right, showing different hook shapes.</p>
<p>Saddle Hook 16 cm 12 mm AH-01-915</p>	<p>Hooklet 16 cm AH-01-916</p>
<p>The image shows a long, thin surgical instrument with a textured handle and a hook-like head. To the left of the main instrument are four smaller versions of the head, labeled D, C, B, and A from left to right, showing different hook shapes.</p>	<p>The image shows a long, thin surgical instrument with a textured handle and a hook-like head. To the left of the main instrument are four smaller versions of the head, labeled D, C, B, and A from left to right, showing different hook shapes.</p>
<p>Hooklet 16 cm 14x8 AH-01-917</p>	<p>Hooklet 16.5 cm AH-01-918</p>



	
<p>Hooklet 16.5 cm AH-01-919</p>	<p>Hooklet 17.5 cm Fig.1 AH-01-920</p>
	
<p>Nasal Speculum 6.5 cm AH-01-1601</p>	<p>Nasal Speculum 15.5 cm AH-01-1602</p>





	
<p>Nasal Speculum 13 cm AH-01-1603</p>	<p>Nasal Speculum 12.5 cm AH-01-1604</p>
	
<p>Nasal Speculum 13 cm AH-01-1605</p>	<p>Nasal Speculum 13 cm AH-01-1606</p>

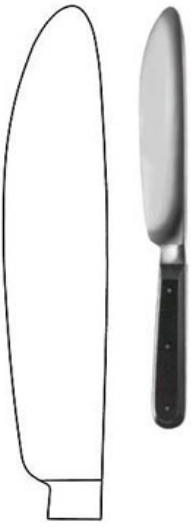
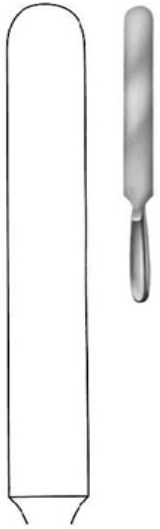



	
<p>Nasal Speculum          13.5 cm          AH-01-1607</p>	<p>Cottle black          13.5 cm          AH-01-1608</p>
	
<p>Nasal Tampon Forceps          14.5 cm          AH-01-1609</p>	<p>Nasal Tampon Forceps          18.5 cm          AH-01-1610</p>





	
<p>Nasal Tampon Forceps 21.5 cm</p>	<p>Nasal Tampon Forceps 18.5 cm AH-01-1612</p>
	
<p>Scalpels 15.5 cm AH-301</p>	<p>Scalpels 25.5 cm AH-302</p>











	
<p>Scalples        20cm        AH-303</p>	<p>Scalples        38 cm        AH-304</p>
	
<p>Scalples        AH-305        \$3.90</p>	<p>Scalples        16 cm        AH-306</p>





	
<p>Scalpels 21 cm AH-307</p>	<p>Scalpels 21 cm AH-308</p>
	
<p>Scalpels 13.5 cm AH-309</p>	<p>Scalpels 12 cm AH-311</p>



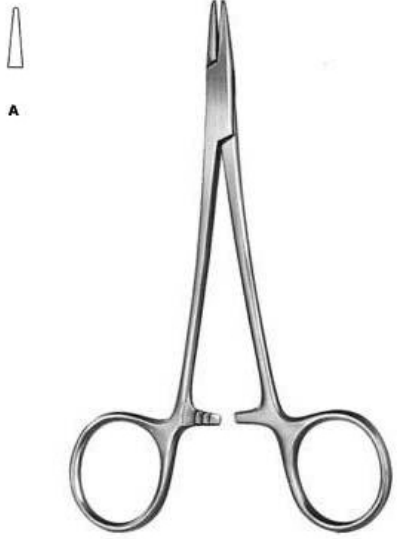

	
<p>Scalpels 12 cm AH-312</p>	<p>Scalpels 12 cm AH-313</p>
	
<p>Scalpels 21.5 cm AH-314 \$7.50</p>	<p>Scalpels 21 cm AH-315</p>

	
<p>Scalpels 16 cm AH-316 \$12.00</p>	<p>Scalpels 12.5 cm AH-317</p>
	
<p>Scalpels 15.5 cm AH-318</p>	<p>Scalpels 29 cm AH-319</p>

	
<p>Scalpels          32.5 cm          AH-320          \$10.50</p>	<p>Scissors          14.5 cm          AH-401</p>
	
<p>Scissors          14 cm          AH-402</p>	<p>Scissors          16 cm          AH-403</p>

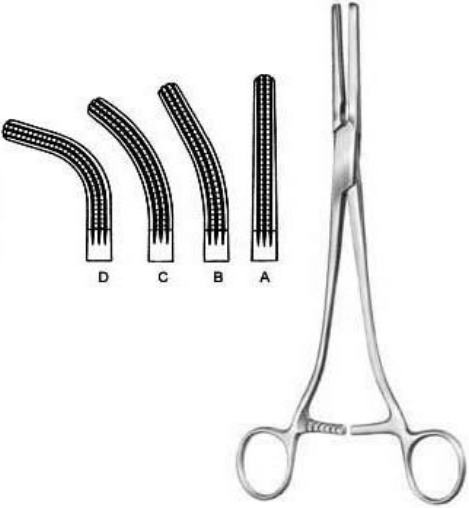

	
<p>Scissors 12 cm AH-405</p>	<p>Scissors 17 cm AH-414</p>
	
<p>Scissors 15 cm AH-415</p>	<p>Scissors 16 cm AH-416</p>



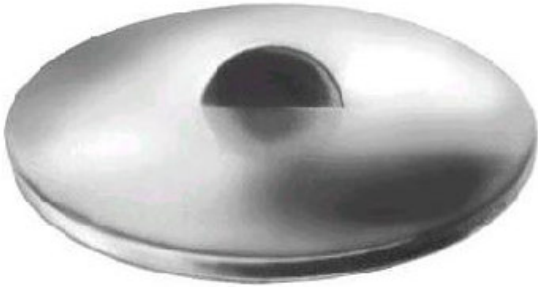

 <p>A</p>	 <p>C B A</p>
<p>Scissors        23 cm        AH-418</p>	<p>Scissors        16 cm        AH-420</p>
 <p>B A</p>	
<p>Splinter Forceps        20.5 cm        AH-601</p>	<p>Splinter Forceps        21 cm        AH-602</p>

	
<p>Splinter Forceps 20 cm Fig.4 20.5 cm Fig.3 21 cm Fig.2 21.5 cm Fig.1 AH-603</p>	<p>Splinter Forceps 23 cm AH-604</p>
	
<p>Splinter Forceps 14.5 cm AH-607</p>	<p>Splinter Forceps 21 cm AH-612\</p>



	
<p>Splinter Forceps 22.5 cm AH-613</p>	<p>Irrigator 1 AH-01-2501</p>
	
<p>Round Bowl 220 MM X 70 MM 400 MM X 150 MM AH-01-2502</p>	<p>Round Bowl ? X h 6.00 i AH-01-2503</p>





	
<p>Flat Dish ? X h 0.20 1 AH-01-2504</p>	<p>Lid only 1 AH-01-2505</p>
	
<p>Stainless Steel ? X h 0.30 i AH-01-2506</p>	<p>Round Dish ? 128 x 38 mm 0.40 1 ? x h 0.30 1 AH-01-2507</p>





	
<p>Flat Dish ? x h 0.15 l AH-01-2508</p>	<p>Measurer 100 cc = 0.1 l AH-01-2509</p>
	
<p>Graduated Inside 0.25 l 0.50 l AH-01-2510</p>	<p>Petri Dish AH-01-2511</p>

	
<p>Petri Dish          1          AH-01-2511</p>	<p>Lid for Petri Dishes          1          AH-01-2513</p>
	
<p>Universal Tray          l x b x h          AH-01-2514</p>	<p>Instrument Tray          l x b x h          AH-01-2515</p>

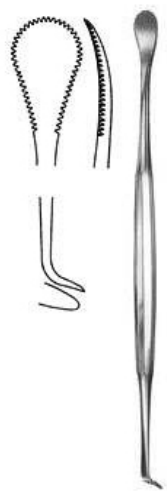

	
<p>Universal Tray l x b x h AH-01-2516</p>	<p>Round Bowl ? x h AH-01-2517</p>
	
<p>Metal Jar ? 30 mm x 90 mm ? 50 mm x 100 mm AH-01-2518</p>	<p>lid with knob l x b x h AH-01-2519</p>

	
<p>lid with knob l x b x h AH-01-2520</p>	<p>Cleft Palate Hooklet 18.5 cm AH-01-1801</p>
	
<p>Cleft Palate Hooklet 18.5 cm AH-01-1802</p>	<p>Cleft Palate Dissector 18 cm AH-01-1804</p>





	
<p>Cleft Palate Elevator 18 cm AH-01-1805</p>	<p>Cleft Palate Elevator 18 cm AH-01-1807</p>
	
<p>Cleft Palate Periosteal Elevator 17 cm AH-01-1808</p>	<p>Cleft Palate Needle 20.5 cm AH-01-1809</p>

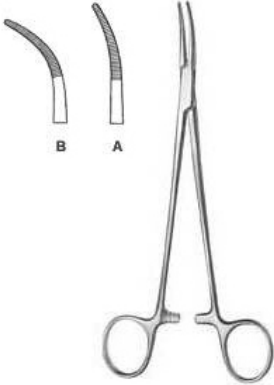
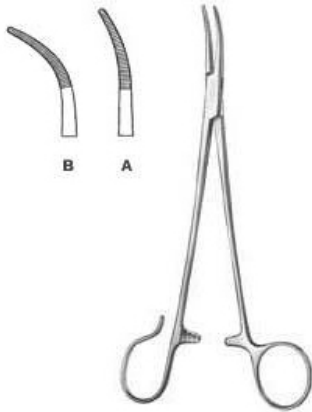

	
<p>Tonsil Knife / Enucleator          25 cm          AH-01-1811</p>	<p>Tonsil Dissector/Retractor          22.5 cm          AH-01-1812</p>
	
<p>Tonsil Elevator          22.5 cm          AH-01-1814</p>	<p>Gauze Packer          17.5 cm          AH-01-1815</p>



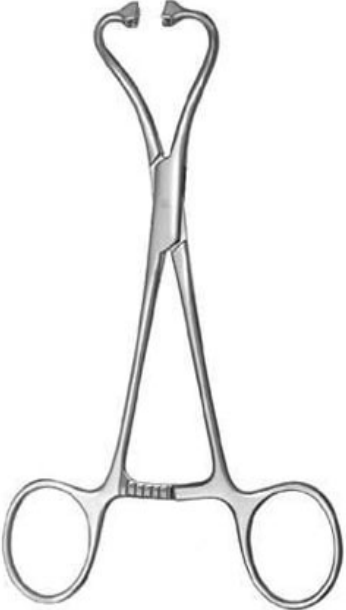



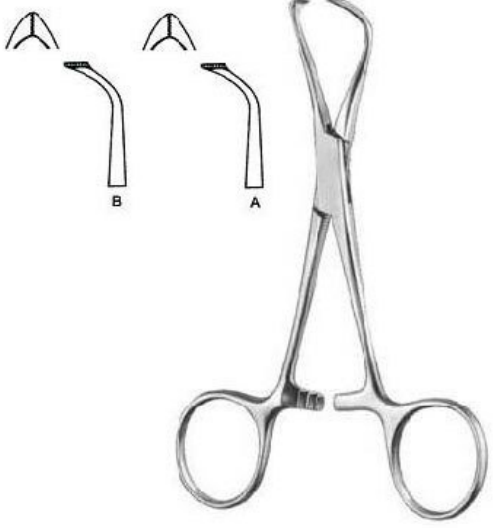
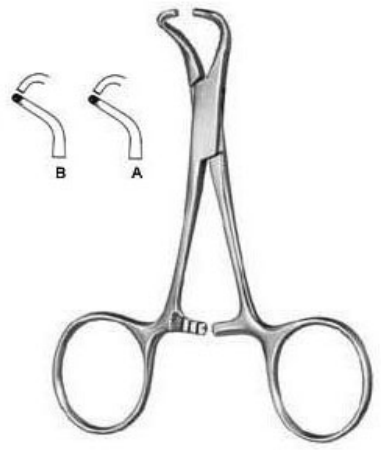

 <p>A pair of long-handled forceps with a curved tip. A separate drawing shows the curved tip in detail.</p>	 <p>A pair of long-handled forceps with a curved tip. A separate drawing shows the curved tip in detail.</p>
<p>Tonsil Grasping Forceps 18 cm AH-01-1817</p>	<p>Tonsil Grasping Forceps 20 cm AH-01-1818</p>
 <p>A pair of long-handled forceps with a curved tip. Two separate drawings show the curved tip from different angles, labeled 'B' and 'A'.</p>	 <p>A pair of long-handled forceps with a curved tip. Two separate drawings show the curved tip from different angles, labeled 'B' and 'A'.</p>
<p>Tonsil Forceps 19 cm AH-01-1819</p>	<p>Tonsil Forceps 18.5 cm AH-01-1820</p>

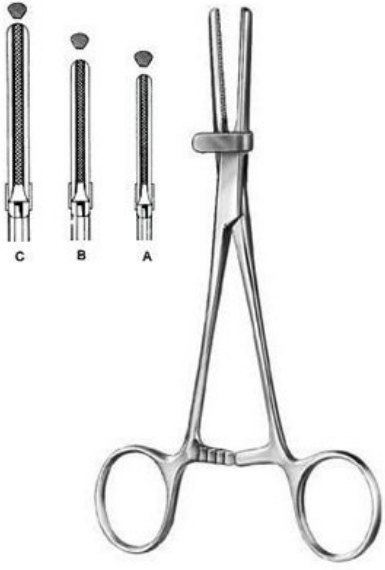
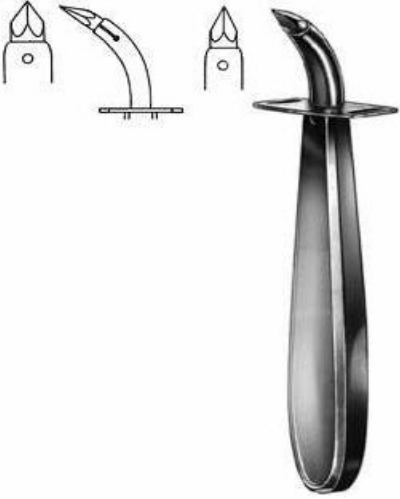

	
<p>Towel &amp; Tubing Clamps 9 cm AH-801</p>	<p>Towel &amp; Tubing Clamps 5.5 cm 8.5 cm</p>
	
<p>Towel &amp; Tubing Clamps 8.5 cm AH-803</p>	<p>Towel &amp; Tubing Clamps 11.5 cm 13 cm AH-804</p>

	
<p>Towel &amp; Tubing Clamps          11.5 cm          AH-805</p>	<p>Towel &amp; Tubing Clamps          13 cm          AH-806</p>
	
<p>Towel &amp; Tubing Clamps          15.5 cm          AH-807</p>	<p>Towel &amp; Tubing Clamps          13.5 cm          AH-808</p>

	
<p>Towel &amp; Tubing Clamps 13 cm 9.5 cm AH-809</p>	<p>Towel &amp; Tubing Clamps 10.5 cm blunt 13.5 cm blunt 14.5 cm AH-811</p>
	
<p>Towel &amp; Tubing Clamps 19.5 cm AH-812</p>	<p>Towel &amp; Tubing Clamps AH-813</p>



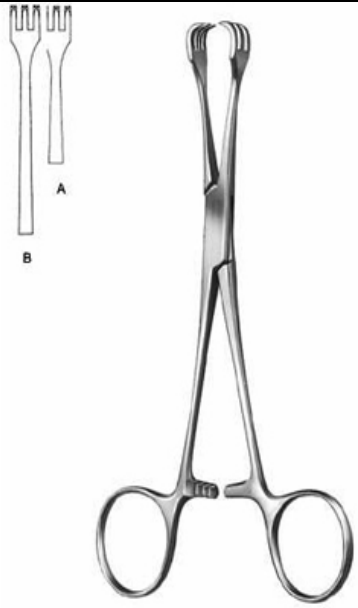

	
<p>Towel &amp; Tubing Clamps 14 cm AH-814</p>	<p>Towel &amp; Tubing Clamps 19 cm AH-815</p>
	
<p>Towel &amp; Tubing Clamps 15.5 cm AH-816</p>	<p>Tracheotomy Trocar 11.5 cm AH-01-1901</p>





 <p>Diagram showing two hook configurations labeled 'B' and 'A'. The main image shows a long, thin metal hook with a curved tip.</p>	 <p>Diagram showing two hook configurations. The main image shows a metal hook with a curved tip and a textured grip section on the handle.</p>
<p>Tracheal Hook          17 cm          AH-01-1902</p>	<p>Tracheal Hook          13.5 cm          AH-01-1903</p>
 <p>Diagram showing two hook configurations. The main image shows a long, thin metal hook with a curved tip.</p>	 <p>Diagram showing two hook configurations. The main image shows a metal hook with a curved tip and a textured grip section on the handle.</p>
<p>Tracheal Hook          11 cm          AH-01-1904</p>	<p>Tracheal Hook          15 cm          AH-01-1905</p>





 <p>A long, thin surgical instrument with a hook at the top and a curved hook at the bottom. Two small diagrams above show the hook's profile and a detail of the curved hook.</p>	 <p>A long, thin surgical instrument with a curved blade at the top and a handle at the bottom. A small diagram above shows the blade's profile.</p>
<p>Thymus Retractor 17.5 cm AH-01-1906</p>	<p>Goitre Enucleator 16.5 cm AH-01-1908</p>
 <p>A long, thin surgical instrument with a curved blade at the top and a handle at the bottom. A small diagram above shows the blade's profile.</p>	 <p>A pair of surgical forceps with two long, thin handles and two circular rings at the bottom. A small diagram above shows the handles with labels 'A' and 'B'.</p>
<p>Goitre Enucleator 20.5 cm AH-01-1910</p>	<p>Goitre Grasping Forceps 15.5 cm AH-01-1911</p>



	
<p>Tracheal Tube AH-01-1912</p>	<p>Tracheal Tube AH-01-1913</p>
	
<p>Tracheal Tube outer tube closed inner tube closed silver AH-01-1914</p>	<p>Speaking Tube AH-01-1915</p>





	
<p>Trocars 14 cm AH-101</p>	<p>Trocars 20 cm AH-102</p>
	
<p>Trocars 18.5 cm AH-103</p>	<p>Trocars 20 cm AH-104</p>



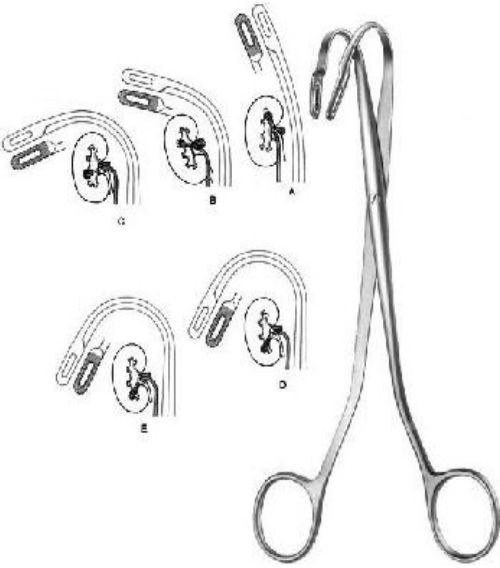
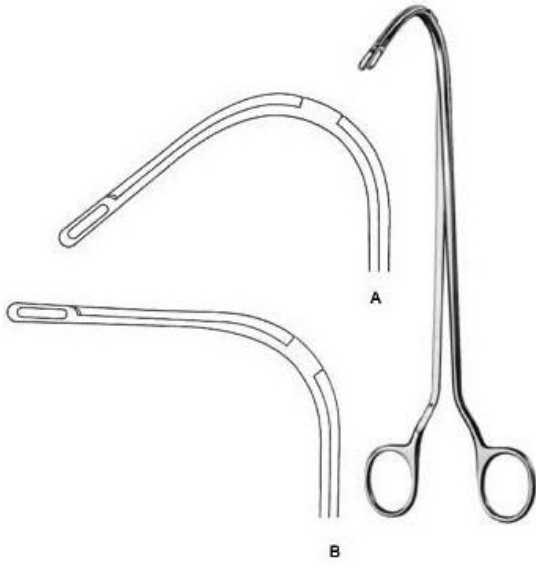

	
<p>Trocars        24.5 cm        AH-105</p>	<p>Trocars        24 cm        AH-106</p>
	
<p>Trocars        19.5 cm        AH-107</p>	<p>Trocars        18 cm        AH-108</p>

	
<p>Trocars 12cm AH-109</p>	<p>Trocars 21.59 cm AH-110</p>
	
<p>Trocars 22 cm AH-112</p>	<p>Trocars 22.5 cm AH-113</p>

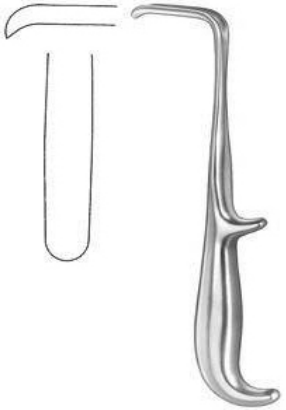
	
<p>Trocars          21 cm          AH-114</p>	<p>Trocars          AH-116</p>
	
<p>Kidney Stone Forceps          19 CM FIG.3          21 CM FIG.2          23 CM FIG.1          AH-01-2201</p>	<p>Kidney Stone Forceps          23 cm          24.5 cm          AH-01-2202</p>

<p>Kidney Stone Forceps 16 cm Fig.1 17 cm Fig.2 AH-01-2203</p>	<p>Nephrostomy Forceps 21 cm Fig.1 21 cm Fig.2 AH-01-2204</p>
<p>Gall Duct Dilator 32 cm AH-01-2205</p>	<p>Gall Stone Forceps 21 cm AH-01-2206</p>

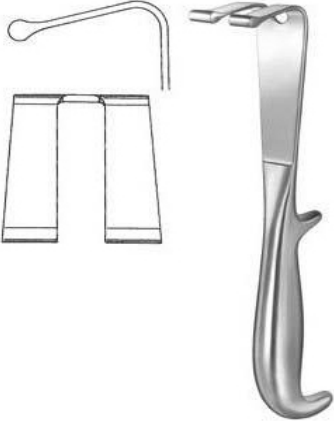
	
<p>Gall Stone Forceps 21 cm AH-01-2207</p>	<p>Gall Stone Forceps 21.5 cm AH-01-2209</p>
	
<p>Gall Stone Forceps 23 cm AH-01-2210</p>	<p>Prostatic Retractor 21.5 cm AH-01-2212</p>

	
<p>Prostatic Retractor 20.5 cm AH-01-2213</p>	<p>Prostatic Retractor 22 cm AH-01-2214</p>
	
<p>Prostatic Retractor 21.5 cm AH-01-2215</p>	<p>Capsule Forceps 24.5 cm AH-01-2216</p>

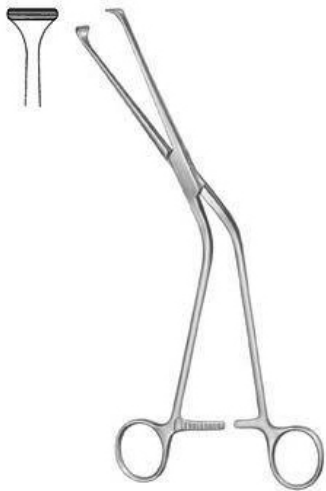
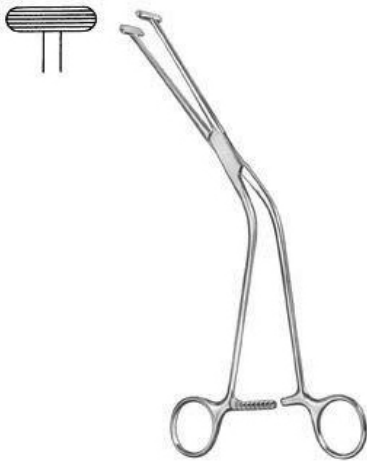
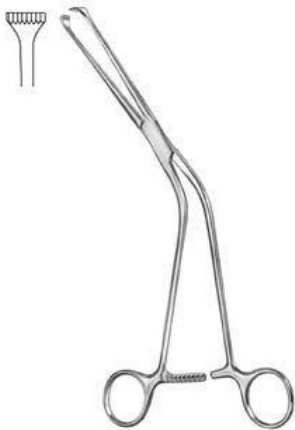
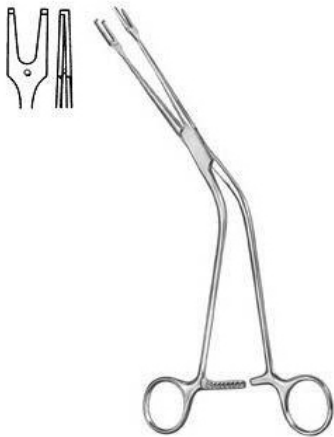
	
<p>Capsule Forceps          22 cm          AH-01-2217</p>	<p>Capsule Forceps          24.5 cm          AH-01-2218</p>
	
<p>Capsule Forceps          22 cm          AH-01-2219</p>	<p>Ligature Carrying Forceps          24.5 cm          AH-01-2220</p>

**High quality instruments exact prices of surgical instruments**